

PC-IH0-US-27189

ProInox H0

Stainless steel kitchen sink
Handcrafted
Urban style corners [0"]

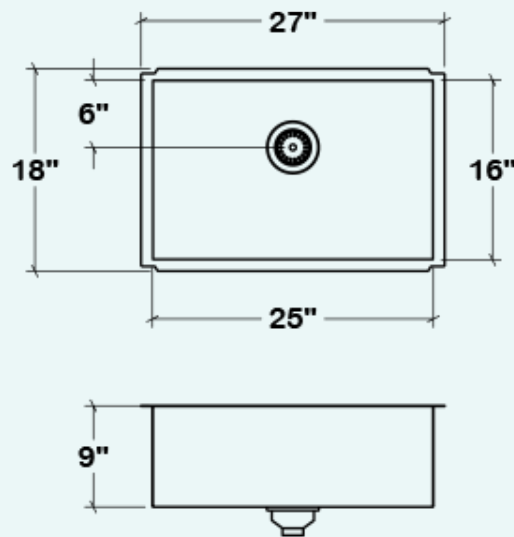

Installation

Undermount

Bowl

25" x 16" x 9"

Overall

27" x 18" x 9"

Recommended cabinet

30"

Drain

Ø 3 1/2"

Packaging

32 1/8" x 23 1/4" x 14 3/8"
25 lbs

Features

- SET INCLUDES: Sink, stainless steel strainer (AA-SA-3.5-SA) and mounting hardware included, cutout template for overhang installation
- UNDERMOUNT INSTALLATION: Undermount sinks are usually installed underneath a solid piece of countertop material. This installation allows to easily wipe water and crumbs into sink without getting caught between the sink edge and the countertop. It also has the advantage to create a clean look.
- STAINLESS STEEL – 18 gauge
- STRONG: Corrosion resistant material - 304 series (18/10)
- QUIET: Sound deadening pads for maximum noise reduction
- MODERN ZERO RADIUS CORNERS maximize workspace in the sink
- DRAIN located towards rear providing more space under the sink
- LIFETIME LIMITED WARRANTY: Satisfaction guaranteed with customer service that cares
- Product certified ASME A112.19.3, CSA B45.0, and CSA B45.4
- PROUDLY DESIGNED IN NORTH AMERICA

Must-have accessories

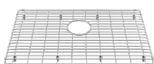

Grid
IH-G-2516



Colander
IH-CA-16



Bin
IH-BI-16



Wood cutting board
IH-BA-16-MA

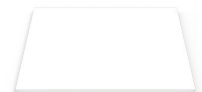

Plastic cutting board
IH-BB-16-WH